

**Modern Disc Style Deadbolt**

---

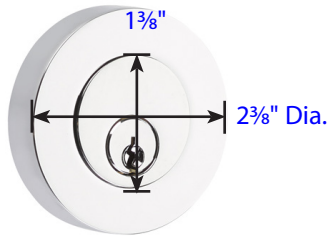

Exterior Trim (8423)  
 • Projection is 1 1/2"  
 • 8323 same on both sides

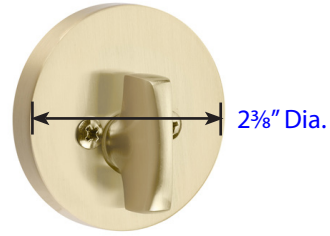

Interior Trim (8423)  
 • Projection is 1"  
 • Thickness is 5/16"

**Square Style Deadbolt**

---

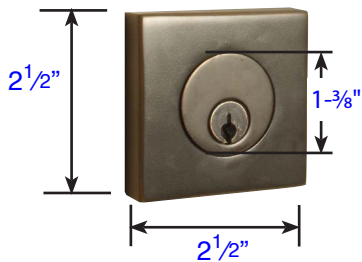

Exterior Trim (8469)  
 • Projection is 5/8"  
 • 8369 same on both sides

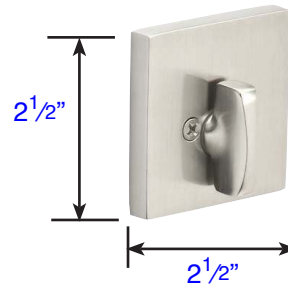

Interior Trim (8469)  
 • Projection is 1 1/4"  
 • Thickness is 5/16"

**Modern Style Deadbolt**

---

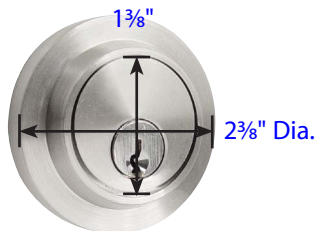

Exterior Trim (8467)  
 • Projection is 5/8"  
 • 8367 same on both sides

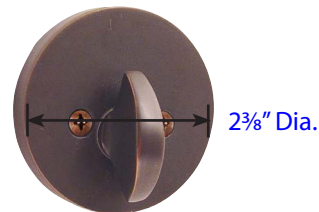

Interior Trim (8467)  
 • Projection is 1 1/4"  
 • Thickness is 5/16"

**Neos Modern Style Deadbolt**

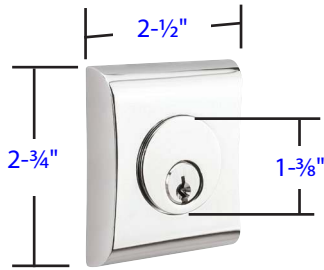

Exterior Trim (8475)  
 • Projection is  $\frac{5}{8}$ "  
 • 8375 same on both sides

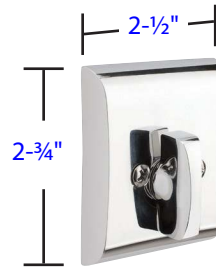

Interior Trim (8475)  
 • Projection is 1"  
 • Thickness is  $\frac{3}{8}$ "

**Urban Modern Style Deadbolt**

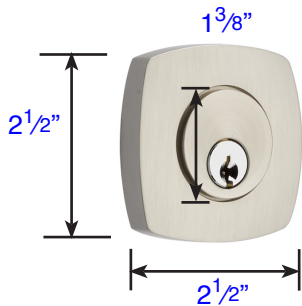

Exterior Trim (8426)  
 • Projection is  $\frac{1}{2}$ "  
 • 8326 same on both sides

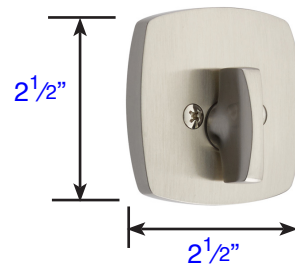

Interior Trim (8426)  
 • Projection is  $\frac{1}{16}$ "  
 • Thickness is  $\frac{3}{8}$ "

**Quincy Style Deadbolt**

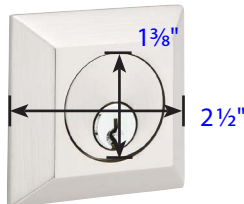

Exterior Trim (8478)  
 • Projection is  $\frac{1}{2}$ "  
 • 8378 same on both sides

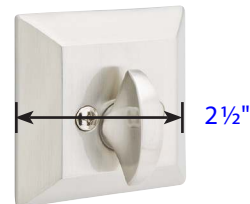

Interior Trim (8478)  
 • Projection is  $\frac{1}{4}$ "  
 • Thickness is  $\frac{5}{16}$ "

**Wilshire Style Deadbolt**

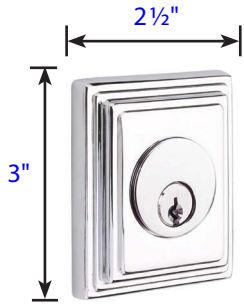

Exterior Trim (8479)  
 • Projection is 1/2"  
 • 8379 same on both sides

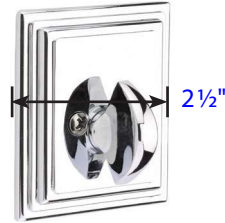

Interior Trim (8479)  
 • Projection is 1"  
 • Thickness is 5/16"

**Regular Style Deadbolt**

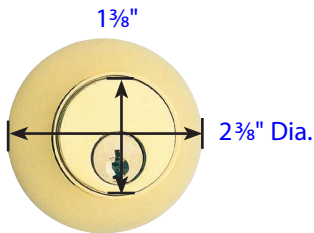

Exterior Trim (8450)  
 • Projection is 1 3/8"  
 • 8350 same on both sides

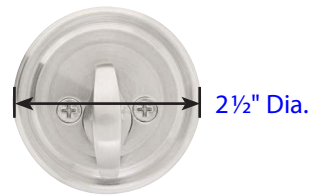

Interior Trim (8450)  
 • Projection is 1 1/4"  
 • Thickness is 5/16"

**Low Profile Style Deadbolt**

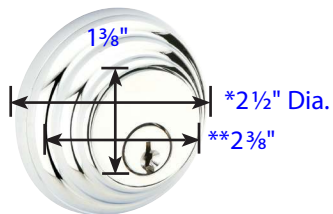

Exterior Trim (8455)  
 • \* 2 1/2" Diameter with Exterior ring  
 • \*\* 2 3/8" Diameter without Exterior ring  
 • Projection with Exterior ring: 7/8"  
 • Projection without Exterior ring: 5/8"  
 • 8355 same both sides

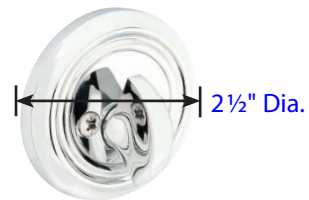

Interior Trim (8455)  
 • Projection is 1 1/4"  
 • Thickness is 5/16"

**Rope Style Deadbolt**

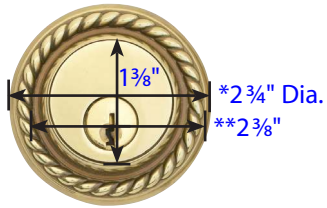

- Exterior Trim (8464)
- \* 2 1/2" Diameter with Exterior ring
  - \*\* 2 3/8" Diameter without Exterior ring
  - Projection with ext. ring: 1 1/16"
  - Projection without ext. ring: 1/2"
  - 8364 same both sides



- Interior Trim (8464)
- Projection is 1 1/4"
  - Thickness is 5/16"

**#8 Style Deadbolt**

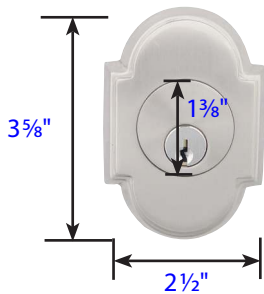

- Exterior Trim (8466)
- Projection is 1/2"
  - 8366 same on both sides

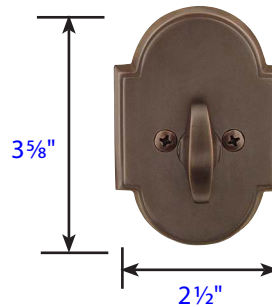

- Interior Trim (8466)
- Projection is 1 1/4"
  - Thickness is 5/16"

**Rectangular Style Deadbolt**

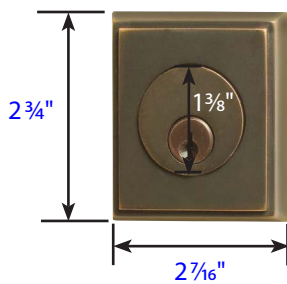

- Exterior Trim (8468)
- Projection is 9/16"
  - 8368 same on both sides

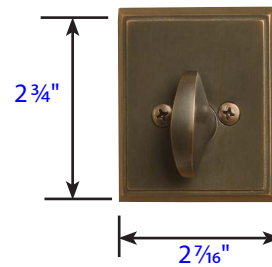

- Interior Trim (8468)
- Projection is 1 1/4"
  - Thickness is 9/32"

**Knoxville Style Deadbolt**

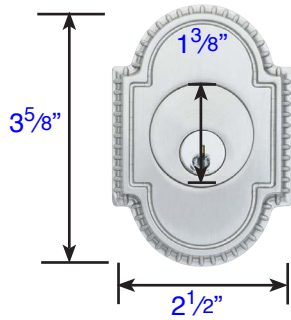

Exterior Trim (8459)  
 • Projection is 1/2"  
 • 8359 same on both sides

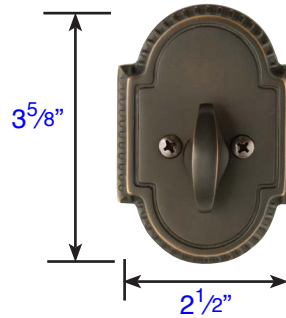

Interior Trim (8459)  
 • Projection is 1 1/4"  
 • Thickness is 1/2"

**Arts & Crafts Style Deadbolt**

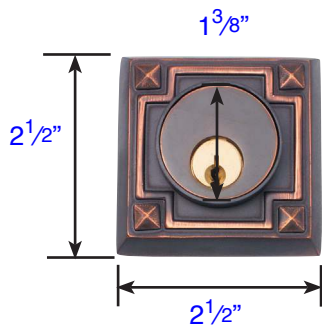

Exterior Trim (8454)  
 • Projection is 9/16"  
 • 8354 same on both sides

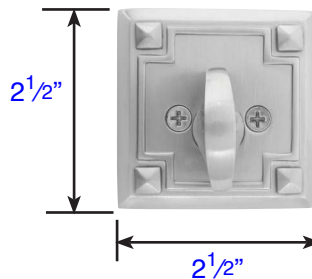

Interior Trim (8454)  
 • Projection is 1 1/4"  
 • Thickness is 5/16"

**Saratoga Style Deadbolt**

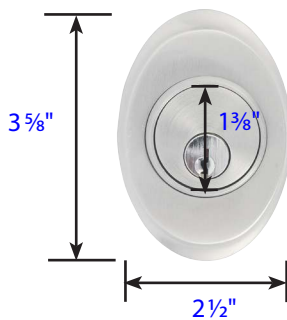

Exterior Trim (8458)  
 • Projection is 1/2"  
 • 8358 same on both sides

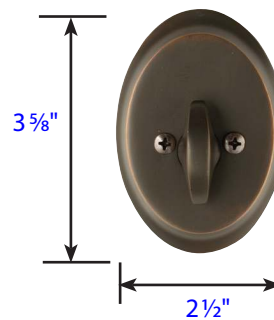

Interior Trim (8458)  
 • Projection is 1 1/4"  
 • Thickness is 1/2"

**Bronze Regular Style Deadbolt**



2<sup>3</sup>/<sub>8</sub>" Dia.

Exterior Trim (8450)  
 • Projection is 1"  
 • 8350 same on both sides



2<sup>1</sup>/<sub>2</sub>" Dia.

Interior Trim (8450)  
 • Projection is 1<sup>1</sup>/<sub>4</sub>"  
 • Thickness is 5/16"

**#1 Style Plate with Flap Deadbolt**

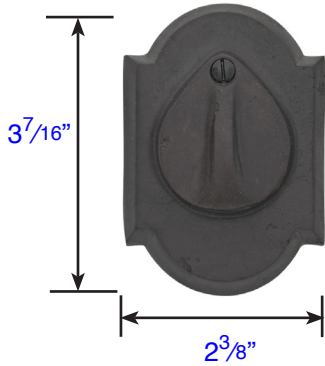

Exterior Trim (8457)  
 • Projection is 1<sup>3</sup>/<sub>16</sub>"  
 • 8357 same on both sides

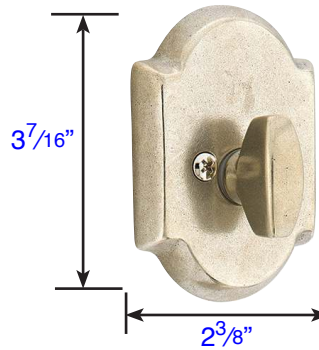

Interior Trim (8457)  
 • Projection is 1<sup>1</sup>/<sub>4</sub>"  
 • Thickness is 1/2"

**#3 Style Plate with Flap Deadbolt**

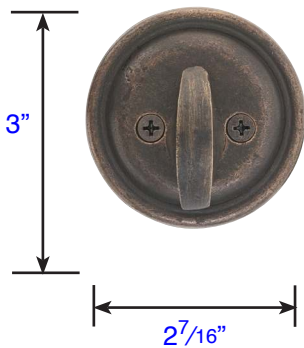

Exterior Trim (8465)  
 • Projection is 1<sup>1</sup>/<sub>16</sub>"  
 • 8365 same on both sides

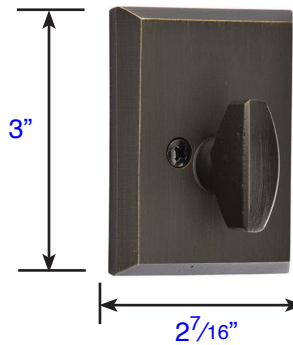

Interior Trim (8465)  
 • Projection is 1<sup>1</sup>/<sub>4</sub>"  
 • Thickness is 1/2"

**Sandcast Bronze Rustic Modern Rectangular Style Deadbolt**

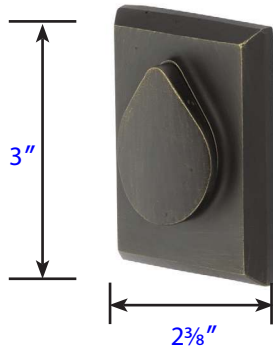

Exterior Trim (8477)  
 • Projection is  $1\frac{1}{16}$ "  
 • 8377 same on both sides

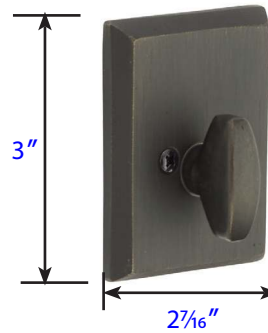

Interior Trim (8477)  
 • Projection is  $1\frac{1}{4}$ "  
 • Thickness is  $\frac{1}{2}$ "

**#4 Style Plate with Flap Deadbolt (Discontinued)**

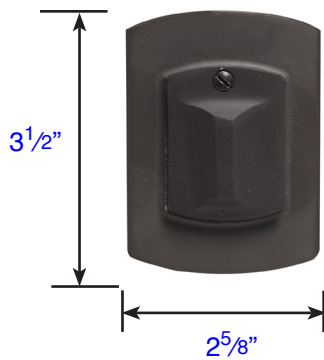

Exterior Trim (8474)  
 • Projection is  $1\frac{1}{16}$ "  
 • 8374 same on both sides

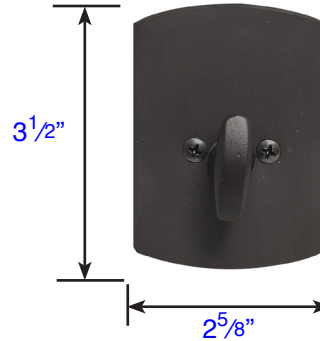

Interior Trim (8474)  
 • Projection is  $1\frac{1}{4}$ "  
 • Thickness is  $\frac{3}{8}$ "

**#6 Ridgemont Style Plate with Flap Deadbolt**

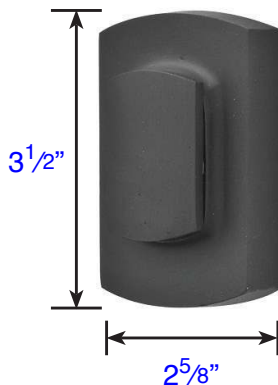

Exterior Trim (8476)  
 • Projection is  $1\frac{5}{16}$ "  
 • 8376 same on both sides

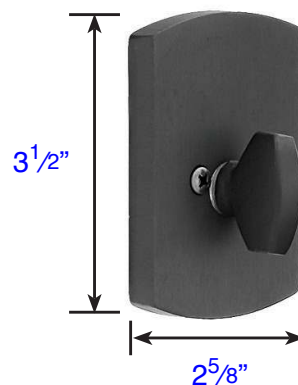

Interior Trim (8476)  
 • Projection is  $1\frac{5}{16}$ "  
 • Thickness is  $\frac{1}{2}$ "

**Tuscany Style Deadbolt**

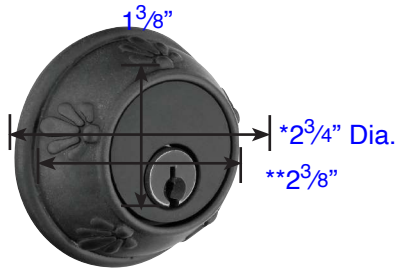

- Exterior Trim (8456)
- \* 2<sup>3</sup>/<sub>4</sub>" Diameter with Exterior ring
  - \*\* 2<sup>3</sup>/<sub>8</sub>" Diameter without Exterior ring
  - Projection with ext. ring: 1"
  - Projection without ext. ring: 1<sup>1</sup>/<sub>16</sub>"
  - 8356 same both sides

- Interior Trim (8456)
- Projection is 1<sup>1</sup>/<sub>4</sub>"
  - Thickness is 5<sup>5</sup>/<sub>16</sub>"

**Tuscany Classic Style Deadbolt**

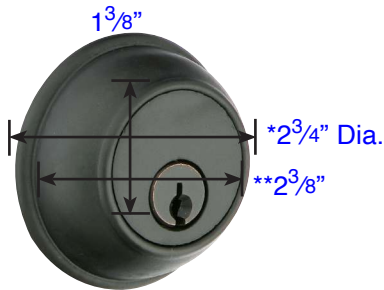

- Exterior Trim (8471)
- \* 2<sup>3</sup>/<sub>4</sub>" Diameter with Exterior ring
  - \*\* 2<sup>3</sup>/<sub>8</sub>" Diameter without Exterior ring
  - Projection with ext. ring: 1"
  - Projection without ext. ring: 1<sup>1</sup>/<sub>16</sub>"
  - 8371 same both sides

- Interior Trim (8471)
- Projection is 1<sup>1</sup>/<sub>4</sub>"
  - Thickness is 5<sup>5</sup>/<sub>16</sub>"

**Octagon Style Deadbolt**

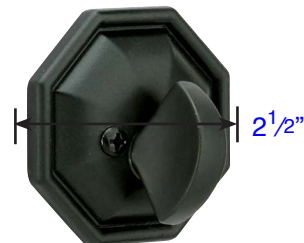
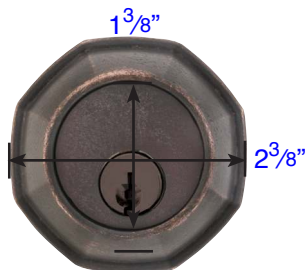

- Exterior Trim (8460)
- Projection is 3<sup>3</sup>/<sub>4</sub>"
  - 8360 same on both sides

- Interior Trim (8460)
- Projection is 1<sup>1</sup>/<sub>4</sub>"
  - Thickness is 5<sup>5</sup>/<sub>16</sub>"



#11 Style Deadbolt

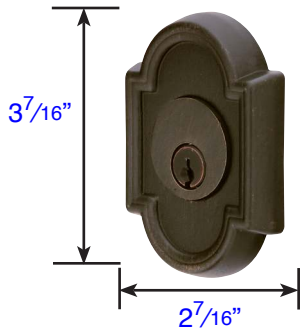

Exterior Trim (8472)  
 • Projection is  $\frac{11}{16}$ "  
 8372 same both sides

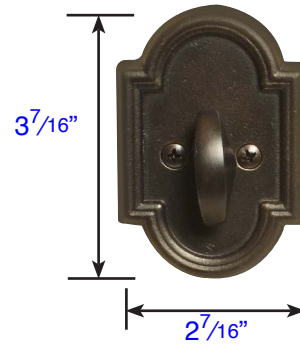

Interior Trim (8472)  
 • Projection is  $1\frac{1}{4}$ "  
 • Thickness is  $\frac{9}{16}$ "

#14 Style Deadbolt

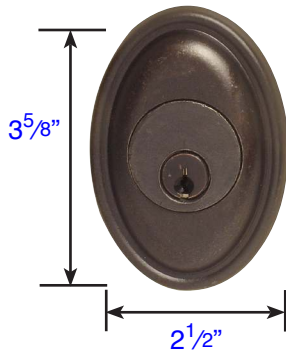

Exterior Trim (8473)  
 • Projection is  $\frac{11}{16}$ "  
 8373 same both sides

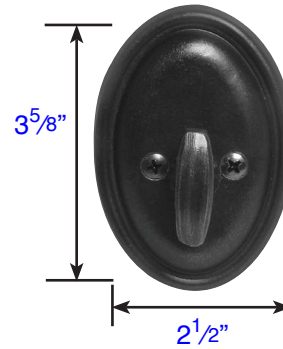

Interior Trim (8473)  
 • Projection is  $1\frac{1}{4}$ "  
 • Thickness is  $\frac{9}{16}$ "

#1 Style Deadbolt

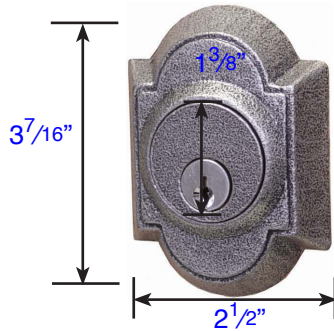

Exterior Trim (8461)  
 • Projection is  $\frac{5}{8}$ "  
 • 8361 same on both sides

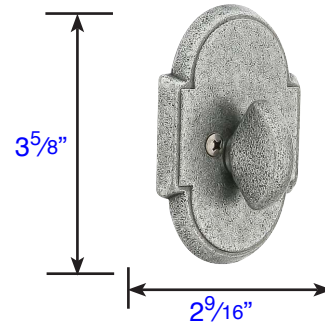

Interior Trim (8461)  
 • Projection is  $1\frac{1}{4}$ "  
 • Thickness is  $\frac{1}{4}$ "

#2 Style Deadbolt

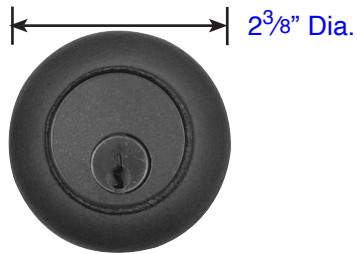

Exterior Trim (8452)  
 • Projection is  $2\frac{3}{8}$ "  
 • 8350 same on both sides

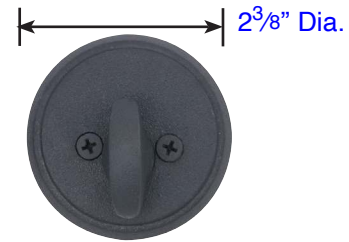

Interior Trim (8452)  
 • Projection is  $1\frac{1}{4}$ "  
 • Thickness is  $\frac{1}{4}$ "

#3 Style Deadbolt

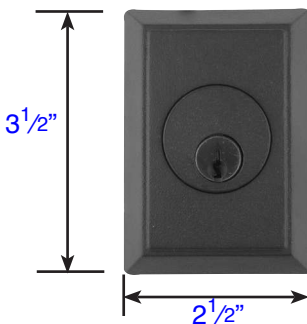

Exterior Trim (8463)  
 • Projection is  $2\frac{1}{2}$ "  
 • 8363 same on both sides

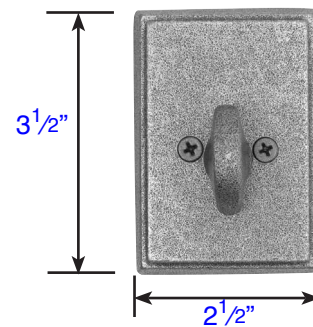

Interior Trim (8463)  
 • Projection is  $1\frac{1}{4}$ "  
 • Thickness is  $\frac{1}{4}$ "

**Regular Sandcast Bronze (8450)**

STANDARD DOOR THICKNESS: 1-1/4" - 1-3/4"	EXTENDED DOOR THICKNESS: 1-7/8" - 2"	EXTENDED DOOR THICKNESS: 2-1/8" - 2-5/8"	EXTENDED DOOR THICKNESS: 2-3/4" - 2-7/8"
• Single cylinder tailpiece	• Single cylinder tailpiece	• Long single cylinder tailpiece	• Extra long single cylinder tailpiece
• 2-1/4" + 2-1/2" screws	• 2-1/2" screws for 1-7/8" door	• 3" screws for 2-1/8" - 2-3/8" door	• 3-1/2" screws
• Deadbolt strike plate	• 3" screws for 2" door	• 3-1/2" screws for 2-1/2" - 2-5/8" door	• Deadbolt strike plate
• Deadbolt understrike plate	• Deadbolt strike plate	• Deadbolt strike plate	• Deadbolt understrike plate
	• Deadbolt understrike plate	• Deadbolt understrike plate	

**#1 sandcast bronze (8457), Brass Regular (8450), Wrought Steel #2 (8452)**

STANDARD DOOR THICKNESS: 1-1/4" - 1-7/8"	EXTENDED DOOR THICKNESS: 2"	EXTENDED DOOR THICKNESS: 2-1/8" - 2-3/4"	EXTENDED DOOR THICKNESS: 2-7/8" - 3"
• Single cylinder tailpiece	• Single cylinder tailpiece	• Long single cylinder tailpiece	• Extra long single cylinder tailpiece
• 2-1/4" screws	• 2-1/2" screws	• 3" screws for 2-1/8" - 2-1/2" door	• 3-1/2" screws
• Deadbolt strike plate	• Deadbolt strike plate	• 3-1/2" screws for 2-5/8" - 2-3/4" door	• Deadbolt strike plate
• Deadbolt understrike plate	• Deadbolt understrike plate	• Deadbolt strike plate	• Deadbolt understrike plate
		• Deadbolt understrike plate	

**Rustic modern rectangular (8477), #3 Sandcast bronze (8465), Quincy (8478)\***

STANDARD DOOR THICKNESS: 1-1/4" - 1-7/8"	EXTENDED DOOR THICKNESS: 2"	EXTENDED DOOR THICKNESS: 2-1/8" - 2-3/4"	EXTENDED DOOR THICKNESS: 2-7/8" - 3"
• Single cylinder tailpiece	• Single cylinder tailpiece	• Long single cylinder tailpiece	• Extra long single cylinder tailpiece
• 2-1/4" screws	• 2-1/2" screws	• 2-1/2" screws for 2-1/8" door	• 3-1/2" screws
• Deadbolt strike plate	• Deadbolt strike plate	• 3" screws for 2-1/4" - 2-5/8" door	• Deadbolt strike plate
• Deadbolt understrike plate	• Deadbolt understrike plate	• 3-1/2" screws for 2-3/4" door	• Deadbolt understrike plate
		• Deadbolt strike plate	
		• Deadbolt understrike plate	

**Knoxville (8459)\*, Saratoga (8458)\*, Square (8469)\*, Ridgemont Sandcast Bronze (8476),  
Octagon Tuscany (8460), Modern (8467)\*, Tuscany Bronze (8456)\*, Classic Tuscany Bronze (8471)\***

STANDARD DOOR THICKNESS: 1-3/8" - 1-7/8"	EXTENDED DOOR THICKNESS: 2" - 2-1/8"	EXTENDED DOOR THICKNESS: 2-1/4" - 2-7/8"	EXTENDED DOOR THICKNESS: 3"
• Single cylinder tailpiece	• Single cylinder tailpiece	• Long single cylinder tailpiece	• Extra long single cylinder tailpiece
• 2-1/4" screws	• 2-1/2" screws	• 3" screws for 2-1/4" - 2-5/8" door	• 3-1/2" screws
• Deadbolt strike plate	• Deadbolt strike plate	• 3-1/2" screws for 2-3/4" - 2-7/8" door	• Deadbolt strike plate
• Deadbolt understrike plate	• Deadbolt understrike plate	• Deadbolt strike plate	• Deadbolt understrike plate
		• Deadbolt understrike plate	

\*Deadbolt Ring/Collar sent for thin door (up to 1-3/4" door)

## Wrought Steel #1 (8461), Neos (8475)\*, #14 Tuscany Bronze (8473)

STANDARD DOOR THICKNESS: 1-3/8" - 1-7/8"	EXTENDED DOOR THICKNESS: 2" - 2-1/8"	EXTENDED DOOR THICKNESS: 2-1/4" - 2-7/8"	EXTENDED DOOR THICKNESS: 3" - 3-1/4"
• Single cylinder tailpiece	• Single cylinder tailpiece	• Long single cylinder tailpiece	• Extra long single cylinder tailpiece
• 2-1/4" screws	• 2-1/2" screws	• 2-1/2" screws for 2-1/4" door	• 3-1/2" screws
• Deadbolt strike plate	• Deadbolt strike plate	• 3" screws for 2-3/8" - 2-3/4" door	• Deadbolt strike plate
• Deadbolt understrike plate	• Deadbolt understrike plate	• 3-1/2" screws for 2-7/8" door	• Deadbolt understrike plate
		• Deadbolt strike plate	
		• Deadbolt understrike plate	

## Urban Modern (8426)\*, #11 Tuscany Bronze (8472), Modern Disc (8423)\*, Arts & Crafts (8454)\*

STANDARD DOOR THICKNESS: 1-3/8" - 1-7/8"	EXTENDED DOOR THICKNESS: 2" - 2-1/8"	EXTENDED DOOR THICKNESS: 2-1/4" - 2-7/8"	EXTENDED DOOR THICKNESS: 3" - 3-1/4"
• Single cylinder tailpiece	• Single cylinder tailpiece	• Long single cylinder tailpiece	• Extra long single cylinder tailpiece
• 2-1/4" screws	• 2-1/2" screws	• 2-1/2" screws for 2-1/4" door	• 3-1/2" screws
• Deadbolt strike plate	• Deadbolt strike plate	• 3" screws for 2-3/8" - 2-3/4" door	• Deadbolt strike plate
• Deadbolt understrike plate	• Deadbolt understrike plate	• 3-1/2" screws for 2-7/8" door	• Deadbolt understrike plate
		• Deadbolt strike plate	
		• Deadbolt understrike plate	

## Low Profile (8455)\*, Wrought Steel #3 (8463), Rectangular (8468)\*, Rope (8464)\*, Wilshire (8479)\*, #8 (8466)\*

STANDARD DOOR THICKNESS: 1-3/8" - 2"	EXTENDED DOOR THICKNESS: 2-1/8"	EXTENDED DOOR THICKNESS: 2-1/4" - 2-7/8"	EXTENDED DOOR THICKNESS: 3" - 3-1/4"
• Single cylinder tailpiece	• Single cylinder tailpiece	• Long single cylinder tailpiece	• Extra long single cylinder tailpiece
• 2-1/4" screws	• 2-1/2" screws	• 2-1/2" screws for 2-1/4" door	• 3-1/2" screws
• Deadbolt strike plate	• Deadbolt strike plate	• 3" screws for 2-3/8" - 2-3/4" door	• Deadbolt strike plate
• Deadbolt understrike plate	• Deadbolt understrike plate	• 3-1/2" screws for 2-7/8" door	• Deadbolt understrike plate
		• Deadbolt strike plate	
		• Deadbolt understrike plate	

\*Deadbolt Ring/Collar sent for thin door (up to 1-3/4" door)

## SS Round (S50001)\*

STANDARD DOOR THICKNESS: 1-3/8" - 1-7/8"	EXTENDED DOOR THICKNESS: 2"	EXTENDED DOOR THICKNESS: 2-1/8" - 2-3/4"	EXTENDED DOOR THICKNESS: 2-7/8" - 3"
<ul style="list-style-type: none"> <li>Single cylinder tailpiece</li> </ul>	<ul style="list-style-type: none"> <li>Single cylinder tailpiece</li> </ul>	<ul style="list-style-type: none"> <li>Long single cylinder tailpiece</li> </ul>	<ul style="list-style-type: none"> <li>Extra long single cylinder tailpiece</li> </ul>
<ul style="list-style-type: none"> <li>2-1/4" socket cap screws</li> </ul>	<ul style="list-style-type: none"> <li>2-1/2" socket cap screws</li> </ul>	<ul style="list-style-type: none"> <li>2-1/2" socket cap screws for 2-1/8" door</li> </ul>	<ul style="list-style-type: none"> <li>3-1/2" socket cap screws</li> </ul>
<ul style="list-style-type: none"> <li>Deadbolt strike plate</li> </ul>	<ul style="list-style-type: none"> <li>Deadbolt strike plate</li> </ul>	<ul style="list-style-type: none"> <li>3" socket cap screws for 2-1/4" - 2-5/8" door</li> </ul>	<ul style="list-style-type: none"> <li>Deadbolt strike plate</li> </ul>
<ul style="list-style-type: none"> <li>Deadbolt understrike plate</li> </ul>	<ul style="list-style-type: none"> <li>Deadbolt understrike plate</li> </ul>	<ul style="list-style-type: none"> <li>3-1/2" socket cap screws for 2-3/4" door</li> <li>Deadbolt strike plate</li> <li>Deadbolt understrike plate</li> </ul>	<ul style="list-style-type: none"> <li>Deadbolt understrike plate</li> </ul>

## SS Square (S50003)\*

STANDARD DOOR THICKNESS: 1-3/8" - 1-7/8"	EXTENDED DOOR THICKNESS: 2" - 2-1/8"	EXTENDED DOOR THICKNESS: 2-1/4" - 2-7/8"	EXTENDED DOOR THICKNESS: 3"
<ul style="list-style-type: none"> <li>Single cylinder tailpiece</li> </ul>	<ul style="list-style-type: none"> <li>Single cylinder tailpiece</li> </ul>	<ul style="list-style-type: none"> <li>Long single cylinder tailpiece</li> </ul>	<ul style="list-style-type: none"> <li>Extra long single cylinder tailpiece</li> </ul>
<ul style="list-style-type: none"> <li>2-1/4" socket cap screws</li> </ul>	<ul style="list-style-type: none"> <li>2-1/2" socket cap screws</li> </ul>	<ul style="list-style-type: none"> <li>3" socket cap screws for 2-1/4" - 2-5/8" door</li> </ul>	<ul style="list-style-type: none"> <li>3-1/2" socket cap screws</li> </ul>
<ul style="list-style-type: none"> <li>Deadbolt strike plate</li> </ul>	<ul style="list-style-type: none"> <li>Deadbolt strike plate</li> </ul>	<ul style="list-style-type: none"> <li>3-1/2" socket cap screws for 2-3/4" - 2-7/8" door</li> </ul>	<ul style="list-style-type: none"> <li>Deadbolt strike plate</li> </ul>
<ul style="list-style-type: none"> <li>Deadbolt understrike plate</li> </ul>	<ul style="list-style-type: none"> <li>Deadbolt understrike plate</li> </ul>	<ul style="list-style-type: none"> <li>Deadbolt strike plate</li> <li>Deadbolt understrike plate</li> </ul>	<ul style="list-style-type: none"> <li>Deadbolt understrike plate</li> </ul>

## SS Modern Disc (S50004)\*

STANDARD DOOR THICKNESS: 1-3/8" - 2"	EXTENDED DOOR THICKNESS: 2-1/8" - 2-1/4"	EXTENDED DOOR THICKNESS: 2-3/8" - 3"	EXTENDED DOOR THICKNESS: 3-1/8" - 3-1/4"
<ul style="list-style-type: none"> <li>Single cylinder tailpiece</li> </ul>	<ul style="list-style-type: none"> <li>Single cylinder tailpiece</li> </ul>	<ul style="list-style-type: none"> <li>Long single cylinder tailpiece</li> </ul>	<ul style="list-style-type: none"> <li>Extra long single cylinder tailpiece</li> </ul>
<ul style="list-style-type: none"> <li>2-1/4" socket cap screws</li> </ul>	<ul style="list-style-type: none"> <li>2-1/2" socket cap screws</li> </ul>	<ul style="list-style-type: none"> <li>3" socket cap screws for 2-3/8" - 2-3/4" door</li> </ul>	<ul style="list-style-type: none"> <li>3-1/2" socket cap screws</li> </ul>
<ul style="list-style-type: none"> <li>Deadbolt strike plate</li> </ul>	<ul style="list-style-type: none"> <li>Deadbolt strike plate</li> </ul>	<ul style="list-style-type: none"> <li>3-1/2" socket cap screws for 2-7/8" - 3" door</li> </ul>	<ul style="list-style-type: none"> <li>Deadbolt strike plate</li> </ul>
<ul style="list-style-type: none"> <li>Deadbolt understrike plate</li> </ul>	<ul style="list-style-type: none"> <li>Deadbolt understrike plate</li> </ul>	<ul style="list-style-type: none"> <li>Deadbolt strike plate</li> <li>Deadbolt understrike plate</li> </ul>	<ul style="list-style-type: none"> <li>Deadbolt understrike plate</li> </ul>

\*Deadbolt Ring/Collar sent for thin door (up to 1-3/4" door)

## Regular sandcast bronze (8350)

STANDARD DOOR THICKNESS: 1-1/4" - 1-3/4"	EXTENDED DOOR THICKNESS: 1-7/8" - 2-1/4"
• Long double cylinder tailpiece	• Long double cylinder tailpiece
• 3" screws	• 3-1/2" screws
• Deadbolt strike plate	• Deadbolt strike plate
• Deadbolt understrike plate	• Deadbolt understrike plate

## Wrought Steel #2 (8350)

STANDARD DOOR THICKNESS: 1-1/4" - 1-3/4"	EXTENDED DOOR THICKNESS: 1-7/8"	EXTENDED DOOR THICKNESS: 2" - 2-1/2"
• Double cylinder tailpiece	• Long double cylinder tailpiece	• Long double cylinder tailpiece
• 2-1/2"+ 3" screws	• 3" screws	• 3-1/2" screws
• Deadbolt strike plate	• Deadbolt strike plate	• Deadbolt strike plate
• Deadbolt understrike plate	• Deadbolt understrike plate	• Deadbolt understrike plate

## Brass Regular (8350)

STANDARD DOOR THICKNESS: 1-1/4" - 1-3/4"	EXTENDED DOOR THICKNESS: 1-7/8" - 2"	EXTENDED DOOR THICKNESS: 2" - 2-1/2"
• Double cylinder tailpiece	• Long double cylinder tailpiece	• Long double cylinder tailpiece
• 2-1/2"+ 3" screws	• 3" screws	• 3-1/2" screws
• Deadbolt strike plate	• Deadbolt strike plate	• Deadbolt strike plate
• Deadbolt understrike plate	• Deadbolt understrike plate	• Deadbolt understrike plate

## Octagon Tuscany (8360), Wrought Steel #1 (8361)

STANDARD DOOR THICKNESS: 1-1/2" - 1-3/4"	EXTENDED DOOR THICKNESS: 1-7/8" - 2"	EXTENDED DOOR THICKNESS: 2" - 2-3/4"
• Double cylinder tailpiece	• Double cylinder tailpiece	• Long double cylinder tailpiece
• 2-1/2" screws	• 3" screws	• 3" screws for 2-1/8" - 2-1/4" door
• Deadbolt strike plate	• Deadbolt strike plate	• 3-1/2" screws for 2-3/8" - 2-3/4" door
• Deadbolt understrike plate	• Deadbolt understrike plate	• Deadbolt strike plate
		• Deadbolt understrike plate

\*Deadbolt Ring/Collar sent for thin door (up to 1-3/4" door)

## Tuscany Bronze (8356)\*, Classic Tuscany Bronze (8371)\*

STANDARD DOOR THICKNESS: 1-1/4" - 1-3/4"	EXTENDED DOOR THICKNESS: 1-7/8" - 2-1/8"	EXTENDED DOOR THICKNESS: 2-1/4" - 2-3/4"
• Double cylinder tailpiece	• Double cylinder tailpiece	• Long double cylinder tailpiece
• 2-1/4" + 2-1/2" screws	• 3" screws	• 3" screws for 2-1/4" door
• Deadbolt strike plate	• Deadbolt strike plate	• 3-1/2" screws for 2-3/8" - 2-3/4" door
• Deadbolt understrike plate	• Deadbolt understrike plate	• Deadbolt strike plate
		• Deadbolt understrike plate

## Square (8369)\*, Rectangular (8368)\*

STANDARD DOOR THICKNESS: 1-1/4" - 1-3/4"	EXTENDED DOOR THICKNESS: 1-7/8" - 2-1/8"	EXTENDED DOOR THICKNESS: 2-1/4" - 2-7/8"
• Double cylinder tailpiece	• Double cylinder tailpiece	• Long double cylinder tailpiece
• 2-1/4" + 2-1/2" screws	• 2-1/2" screws for 1-7/8" door	• 3" screws for 2-1/4" - 2-3/8" door
• Deadbolt strike plate	• 3" screws for 2" - 2-1/8" door	• 3-1/2" screws for 2-1/2" - 2-7/8" door
• Deadbolt understrike plate	• Deadbolt strike plate	• Deadbolt strike plate
	• Deadbolt understrike plate	• Deadbolt understrike plate

## #1 Sandcast Bronze (8357)

STANDARD DOOR THICKNESS: 1-5/8" - 1-7/8"	EXTENDED DOOR THICKNESS: 2" - 2-1/8"	EXTENDED DOOR THICKNESS: 2-1/4" - 2-7/8"
• Double cylinder tailpiece	• Double cylinder tailpiece	• Long double cylinder tailpiece
• 2-1/2" screws	• 3" screws	• 3" screws for 2-1/4" - 2-3/8" door
• Deadbolt strike plate	• Deadbolt strike plate	• 3-1/2" screws for 2-1/2" - 2-7/8" door
• Deadbolt understrike plate	• Deadbolt understrike plate	• Deadbolt strike plate
		• Deadbolt understrike plate

## Low Profile (8355)\*, Modern (8367)\*, Arts & Crafts (8354)\*, Rope (8364)\*

STANDARD DOOR THICKNESS: 1-1/4" - 1-3/4"	EXTENDED DOOR THICKNESS: 1-7/8" - 2-1/4"	EXTENDED DOOR THICKNESS: 2-3/8" - 2-7/8"
• Double cylinder tailpiece	• Double cylinder tailpiece	• Long double cylinder tailpiece
• 2-1/4" + 2-1/2" screws	• 2-1/2" screws for 1-7/8" door	• 3" screws for 2-3/8" door
• Deadbolt strike plate	• 3" screws for 2" - 2-1/4" door	• 3-1/2" screws for 2-1/2" - 2-7/8" door
• Deadbolt understrike plate	• Deadbolt strike plate	• Deadbolt strike plate
	• Deadbolt understrike plate	• Deadbolt understrike plate

\*Deadbolt Ring/Collar sent for thin door (up to 1-3/4" door)

## Ridgemont Sandcast Bronze (8376), Wrought Steel #3 (8363), #3 Sandcast Bronze (8365), Rustic Modern Rectangular (8377)

STANDARD DOOR THICKNESS: 1-3/4" - 1-7/8"	EXTENDED DOOR THICKNESS: 2" - 2-1/4"	EXTENDED DOOR THICKNESS: 2-3/8" - 2-7/8"
• Double cylinder tailpiece	• Double cylinder tailpiece	• Long double cylinder tailpiece
• 2-1/2" screws	• 3" screws	• 3" screws for 2-3/8" door
• Deadbolt strike plate	• Deadbolt strike plate	• 3-1/2" screws for 2-1/2" - 2-7/8" door
• Deadbolt understrike plate	• Deadbolt understrike plate	• Deadbolt strike plate
		• Deadbolt understrike plate

## #8 (8366)\*

STANDARD DOOR THICKNESS: 1-3/8" - 1-3/4"	EXTENDED DOOR THICKNESS: 1-7/8" - 2-1/4"	EXTENDED DOOR THICKNESS: 2-3/8" - 3"
• Double cylinder tailpiece	• Double cylinder tailpiece	• Long double cylinder tailpiece
• 2-1/4" screws	• 2-1/2" screws for 1-7/8" - 2" door	• 3" screws for 2-3/8" door
• Deadbolt strike plate	• 3" screws for 2-1/8" - 2-1/4" door	• 3-1/2" screws for 2-1/2" - 3" door
• Deadbolt understrike plate	• Deadbolt strike plate	• Deadbolt strike plate
	• Deadbolt understrike plate	• Deadbolt understrike plate

## Wilshire (8379)\*, Urban Modern (8326)\*, Modern Disc (8323)\*, Neos (8375)\*, Quincy (8378)\*, Saratoga (8358)\*, Knoxville (8359)\*

STANDARD DOOR THICKNESS: 1-1/2" - 1-3/4"	EXTENDED DOOR THICKNESS: 1-7/8" - 2-3/8"	EXTENDED DOOR THICKNESS: 2-1/2" - 3"
• Double cylinder tailpiece	• Double cylinder tailpiece	• Long double cylinder tailpiece
• 2-1/4" screws	• 2-1/2" screws for 1-7/8" - 2" door	• 3" screws for 2-1/2" door
• Deadbolt strike plate	• 3" screws for 2-1/8" - 2-3/8" door	• 3-1/2" screws for 2-5/8" - 3" door
• Deadbolt understrike plate	• Deadbolt strike plate	• Deadbolt strike plate
		• Deadbolt understrike plate

## #14 Tuscany Bronze (8373), #11 Tuscany Bronze (8372)

STANDARD DOOR THICKNESS: 2" - 2-3/8"	EXTENDED DOOR THICKNESS: 2-1/2" - 3"
• Double cylinder tailpiece	• Double cylinder tailpiece
• 2-1/2" screws for 2" - 2-1/8" door	• 3" screws for 2-1/2" - 2-5/8" door
• 3" screws for 2-1/4" - 2-3/8" door	• 3-1/2" screws for 2-3/4" - 3" door
• Deadbolt strike plate	• Deadbolt strike plate
• Deadbolt understrike plate	• Deadbolt understrike plate

\*Deadbolt Ring/Collar sent for thin door (up to 1-3/4" door)



## SS Round (S50002)\*

STANDARD DOOR THICKNESS: 1-1/4" - 1-3/4"	EXTENDED DOOR THICKNESS: 1-7/8" - 2"	EXTENDED DOOR THICKNESS: 2" - 2-3/4"
• Double cylinder tailpiece	• Double cylinder tailpiece	• Long double cylinder tailpiece
• 2-1/2" socket cap screws	• 3" socket cap screws	• 3" socket cap screws for 2-1/8" - 2-1/4" door
• Deadbolt strike plate	• Deadbolt strike plate	• 3-1/2" socket cap screws for 2-3/8" - 2-3/4" door
• Deadbolt understrike plate	• Deadbolt understrike plate	• Deadbolt strike plate
		• Deadbolt understrike plate

## SS Square (S50023)\*

STANDARD DOOR THICKNESS: 1-1/4" - 1-3/4"	EXTENDED DOOR THICKNESS: 1-7/8" - 2-1/8"	EXTENDED DOOR THICKNESS: 2-1/4" - 2-7/8"
• Double cylinder tailpiece	• Double cylinder tailpiece	• Long double cylinder tailpiece
• 2-1/4" socket cap screws	• 2-1/2" socket cap screws for 1-7/8" door	• 3" socket cap screws for 2-1/4" - 2-3/8" door
• Deadbolt strike plate	• 3" socket cap screws for 2" - 2-1/8" door	• 3-1/2" socket cap screws for 2-1/2" - 2-7/8" door
• Deadbolt understrike plate	• Deadbolt strike plate	• Deadbolt strike plate
	• Deadbolt understrike plate	• Deadbolt understrike plate

## SS Modern Disc (S50024)\*

STANDARD DOOR THICKNESS: 1-1/4" - 1-3/4"	EXTENDED DOOR THICKNESS: 1-7/8" - 2-3/8"	EXTENDED DOOR THICKNESS: 2-1/2" - 3"
• Double cylinder tailpiece	• Double cylinder tailpiece	• Long double cylinder tailpiece
• 2-1/4" socket cap screws	• 2-1/2" socket cap screws for 1-7/8" - 2" door	• 3" socket cap screws for 2-1/2" door
• Deadbolt strike plate	• 3" socket cap screws for 2-1/8" - 2-3/8" door	• 3-1/2" socket cap screws for 2-5/8" - 3" door
• Deadbolt understrike plate	• Deadbolt strike plate	• Deadbolt strike plate
		• Deadbolt understrike plate

\*Deadbolt Ring/Collar sent for thin door (up to 1-3/4" door)

Wrought Steel #3 (8553), Brass Regular (8550), Regular Sandcast Bronze (8550), Rectangular (8568), Wrought Steel #1 (8551), Rope (8564), Wrought Steel #2 (8552)

## Quincy (8578), Knoxville (8559)

STANDARD DOOR THICKNESS: 1-1/2" - 2"	EXTENDED DOOR THICKNESS: 2-1/8" - 3"
• Small (1") single cylinder tailpiece	• Single cylinder tailpiece
• 1-3/4" screws	• 2-1/4" screws
• Deadbolt strike plate	• Deadbolt strike plate
• Deadbolt understrike plate	• Deadbolt understrike plate

STANDARD DOOR THICKNESS: 1-3/4" - 2-1/2"	EXTENDED DOOR THICKNESS: 2-5/8" - 3-1/2"
• Small (1") single cylinder tailpiece	• Single cylinder tailpiece
• 1-3/4" screws	• 2-1/4" screws
• Deadbolt strike plate	• Deadbolt strike plate
• Deadbolt understrike plate	• Deadbolt understrike plate

## #1 Sandcast Bronze (8557), #3 Sandcast Bronze (8565), Saratoga (8558), #14 Tuscany Bronze (8573), #11 Tuscany Bronze (8572)

STANDARD DOOR THICKNESS: 1-1/2" - 2-1/8"	EXTENDED DOOR THICKNESS: 2-1/4" - 3"
• Small (1") single cylinder tailpiece	• Single cylinder tailpiece
• 1-3/4" screws	• 2-1/4" screws
• Deadbolt strike plate	• Deadbolt strike plate
• Deadbolt understrike plate	• Deadbolt understrike plate

## SS Round (\$50005), SS Square (\$50006)

STANDARD DOOR THICKNESS: 1-5/8" - 2-1/4"	EXTENDED DOOR THICKNESS: 2-3/8" - 3-1/4"
• Small (1") single cylinder tailpiece	• Single cylinder tailpiece
• 1-3/4" socket cap screws	• 2-1/4" socket cap screws
• Deadbolt strike plate	• Deadbolt strike plate
• Deadbolt understrike plate	• Deadbolt understrike plate

## Neos (8575), Ridgemont Sandcast Bronze (8576), Square (8569), Urban Modern (8526), Modern (8576), Modern Disc (8523)

STANDARD DOOR THICKNESS: 1-5/8" - 2-1/4"	EXTENDED DOOR THICKNESS: 2-3/8" - 3-1/4"
• Small (1") single cylinder tailpiece	• Single cylinder tailpiece
• 1-3/4" screws	• 2-1/4" screws
• Deadbolt strike plate	• Deadbolt strike plate
• Deadbolt understrike plate	• Deadbolt understrike plate

## SS Modern Disc (\$50007)

STANDARD DOOR THICKNESS: 1-3/4" - 2-3/8"	EXTENDED DOOR THICKNESS: 2-1/2" - 3-1/2"
• Small (1") single cylinder tailpiece	• Single cylinder tailpiece
• 1-3/4" socket cap screws	• 2-1/4" socket cap screws
• Deadbolt strike plate	• Deadbolt strike plate
• Deadbolt understrike plate	• Deadbolt understrike plate

## Arts & Crafts (8554), #8 (8566), Octagon Tuscany (8560), Tuscany Bronze (8556), Wilshire (8579)

STANDARD DOOR THICKNESS: 1-3/4" - 2-3/8"	EXTENDED DOOR THICKNESS: 2-1/2" - 3-1/4"
• Small (1") single cylinder tailpiece	• Single cylinder tailpiece
• 1-3/4" screws	• 2-1/4" screws
• Deadbolt strike plate	• Deadbolt strike plate
• Deadbolt understrike plate	• Deadbolt understrike plate

Deadbolt Strike Plates

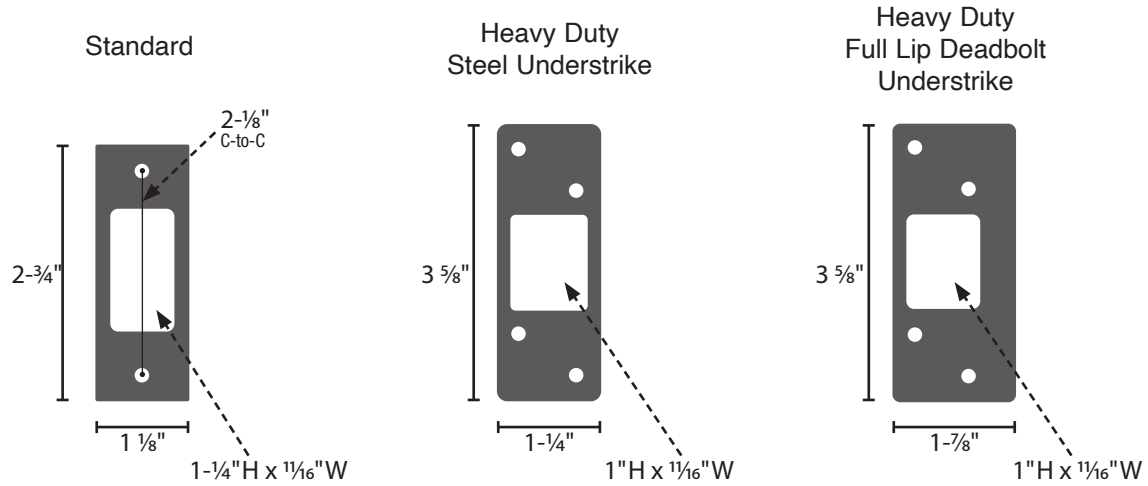

Deadbolt Ring/Collars

